

FCC Information and Copyright

This equipment has been tested and found to comply with the limits of a Class B digital device, pursuant to Part 15 of the FCC Rules. These limits are designed to provide reasonable protection against harmful interference in a residential installation. This equipment generates, uses, and can radiate radio frequency energy and, if not installed and used in accordance with the instructions, may cause harmful interference to radio communications. There is no guarantee that interference will not occur in a particular installation.

The vendor makes no representations or warranties with respect to the contents here and specially disclaims any implied warranties of merchantability or fitness for any purpose. Further the vendor reserves the right to revise this publication and to make changes to the contents here without obligation to notify any party beforehand.

Duplication of this publication, in part or in whole, is not allowed without first obtaining the vendor's approval in writing.

The content of this user's manual is subject to be changed without notice and we will not be responsible for any mistakes found in this user's manual. All the brand and product names are trademarks of their respective companies.



Dichiarazione di conformità sintetica

Ai sensi dell'art. 2 comma 3 del D.M. 275 del 30/10/2002

Si dichiara che questo prodotto è conforme alle normative vigenti e soddisfa i requisiti essenziali richiesti dalle direttive

2004/108/CE, 2006/95/CE e 1999/05/CE

quando ad esso applicabili

Short Declaration of conformity

We declare this product is complying with the laws in force and meeting all the essential requirements as specified by the directives

2004/108/CE, 2006/95/CE and 1999/05/CE

whenever these laws may be applied

Table of Contents

Chapter 1: Introduction	1
1.1 Before You Start.....	1
1.2 Package Checklist.....	1
1.3 Motherboard Specifications	2
1.4 Rear Panel Connectors	3
1.5 Motherboard Layout	4
Chapter 2: Hardware Installation	5
2.1 Install Central Processing Unit (CPU)	5
2.2 Install a Heatsink	7
2.3 Connect Cooling Fans	8
2.4 Install System Memory	9
2.5 Expansion Slots	10
2.6 Jumper Setting	12
2.7 Headers & Connectors	13
Chapter 3: UEFI BIOS & Software	18
3.1 UEFI BIOS Setup	18
3.2 BIOS Update	18
3.3 Software.....	22
Chapter 4: Useful Help	30
4.1 Driver Installation	30
4.2 AMI BIOS Beep Code.....	31
4.3 Troubleshooting.....	31
Appendix: Specifications in Other Languages	33
Arabic	33
French	34
German.....	35
Italian	36
Japanese	37
Polish.....	38
Portuguese	39
Russian.....	40
Spanish.....	41

CHAPTER 1: INTRODUCTION

1.1 Before You Start

Thank you for choosing our product. Before you start installing the motherboard, please make sure you follow the instructions below:

- Prepare a dry and stable working environment with sufficient lighting.
- Always disconnect the computer from power outlet before operation.
- Before you take the motherboard out from anti-static bag, ground yourself properly by touching any safely grounded appliance, or use grounded wrist strap to remove the static charge.
- Avoid touching the components on motherboard or the rear side of the board unless necessary. Hold the board on the edge, do not try to bend or flex the board.
- Do not leave any unfastened small parts inside the case after installation. Loose parts will cause short circuits which may damage the equipment.
- Keep the computer from dangerous area, such as heat source, humid air and water.
- The operating temperatures of the computer should be 0 to 45 degrees Celsius.
- To avoid injury, be careful of:
 - Sharp pins on headers and connectors
 - Rough edges and sharp corners on the chassis
 - Damage to wires that could cause a short circuit

1.2 Package Checklist

- Serial ATA Cable x2
- Rear I/O Panel for ATX Case x1
- User's Manual x1
- Fully Setup Driver DVD x1

<p>Note: The package contents may be different due to the sales region or models in which it was sold. For more information about the standard package in your region, please contact your dealer or sales representative.</p>

1.3 Motherboard Specifications

Specifications	
CPU Support	Socket 1150 for Intel® Core i7 / i5 / i3 / Pentium / Celeron processor Maximum CPU TDP (Thermal Design Power): 95Watt * Please refer to www.biostar.com.tw for CPU support list.
Chipset	INTEL® H81
Memory	Supports Dual Channel DDR3 1066/ 1333/ 1600 2 x DDR3 DIMM Memory Slot, Max. Supports up to 16 GB Memory Each DIMM supports non-ECC 512MB/ 1/ 2/ 4/ 8 GB DDR3 module * Please refer to www.biostar.com.tw for Memory support list.
Storage	INTEL® H81, Supports AHCI 2x SATA 6Gb/s Connector 2x SATA 3Gb/s Connector
LAN	Realtek RTL 8111G 10/ 100/ 1000 Mb/s auto negotiation, Half / Full duplex capability
Audio Codec	ALC892, 7.1 Channels, High Definition Audio, Biostar Hi-Fi (2-channel output is from front audio header)
USB	2x USB 3.0 port (2 on rear I/Os) 6x USB 2.0 port (2 on rear I/Os and 4 via internal headers)
Expansion Slots	5x PCIe 2.0 x1 Slot 1x PCIe 2.0 x16 Slot (x16)
Rear I/Os	1x PS/2 Mouse 1x PS/2 Keyboard 1x DVI Port 1x VGA Port 2x USB 3.0 Port 2x USB 2.0 Port 1x LAN port 3x Audio Jack
Internal I/Os	2x SATA 6.0Gb/s Connector 2x SATA 3.0Gb/s Connector 2x USB 2.0 Header (each header supports 2 USB 2.0 ports) 1x 4-Pin Power Connector 1x 24-Pin Power Connector 1x CPU Fan Connector 2x System Fan Connector 1x Front Panel Header 1x Front Audio Header 1x Clear CMOS Header 1x Serial Port Header 1x S/PDIF out Connector 1x Printer Port Header 1x Consumer IR Header
Form Factor	ATX Form Factor, 295 mm x 210 mm
OS Support	Windows 7/ 8 Biostar reserves the right to add or remove support for any OS with or without notice.

1.4 Rear Panel Connectors

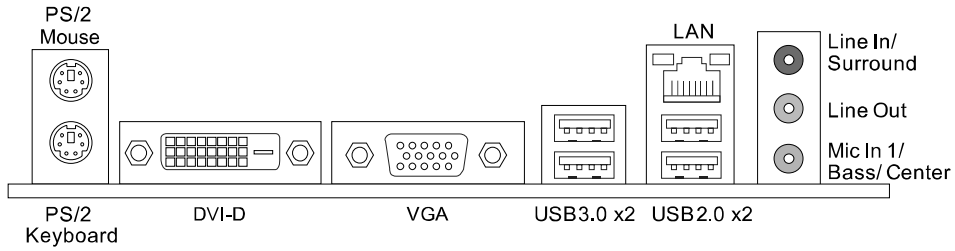

Note1: DVI-D & VGA ports only work with an Intel® integrated Graphics Processor.

Note2: Maximum resolution:
 DVI: 1920 x 1200 @60Hz
 VGA: 1920 x 1200 @60Hz

Note3: To configure 7.1-channel audio, you have to use a chassis with HD front panel audio module and enable the multi-channel audio feature through O.S. Audio Utility.

The 2/ 4/ 5.1/7.1-channel configuration

Port	2-channel	4-channel	5.1 channel	7.1 channel
Blue (Rear Panel)	Line In	Rear Speaker Out	Rear Speaker Out	Rear Speaker Out
Green (Rear Panel)	Line Out	Front Speaker Out	Front Speaker Out	Front Speaker Out
Pink (Rear Panel)	Mic In	Mic In	Center/Subwoofer Out	Center/Subwoofer Out
Green (Front Panel)	--	--	--	Side Speaker Out

1.5 Motherboard Layout

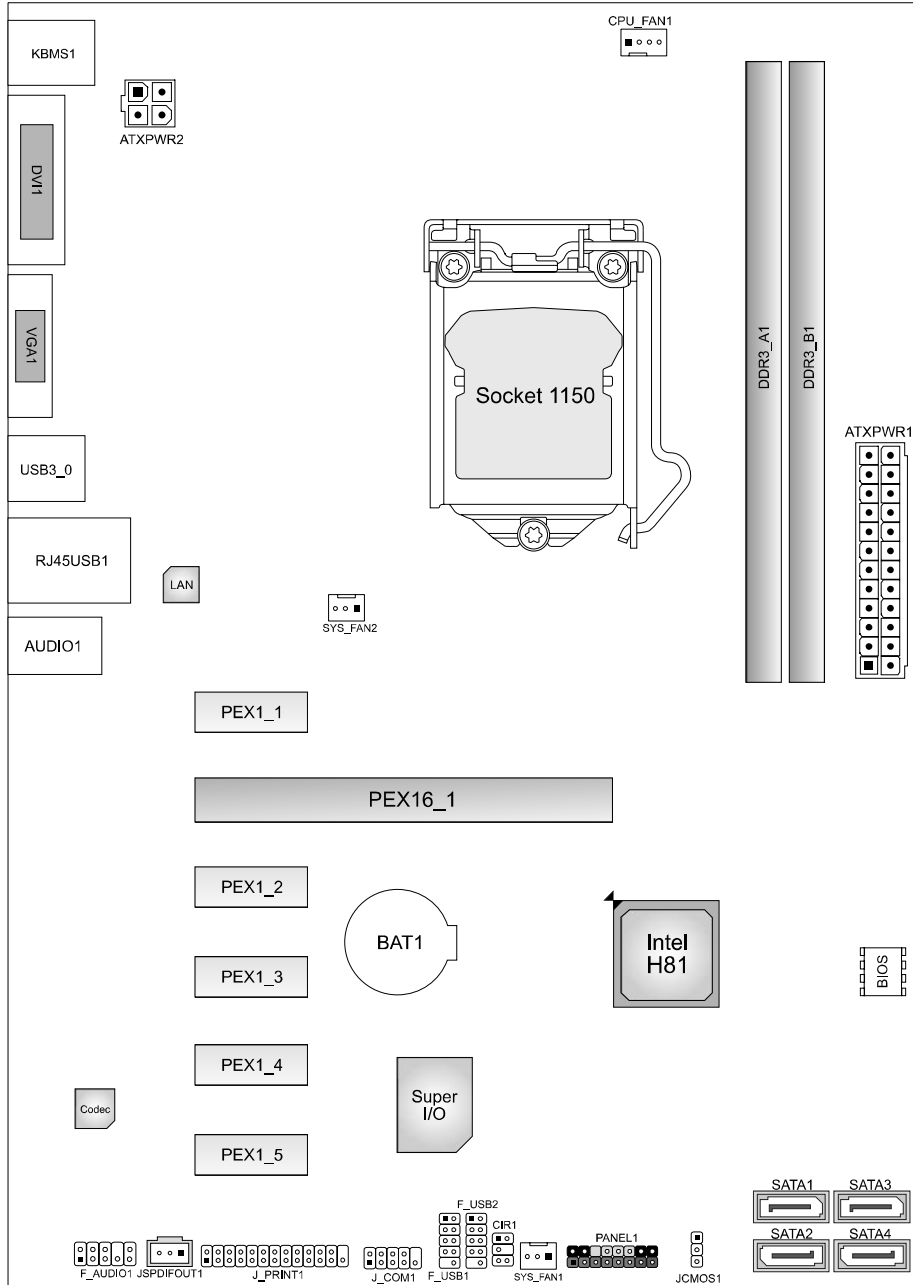

Note: ■ represents the 1st pin.

CHAPTER 2: HARDWARE INSTALLATION

2.1 Install Central Processing Unit (CPU)

Step 1: Locate the CPU socket on the motherboard

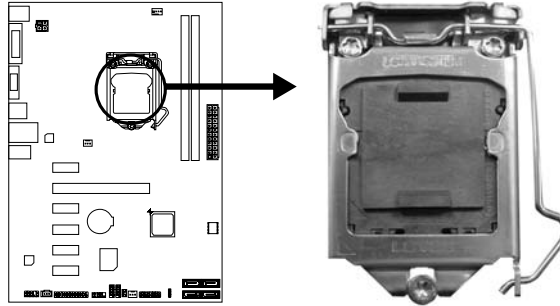

Note1: Remove Pin Cap before installation, and make good preservation for future use. When the CPU is removed, cover the Pin Cap on the empty socket to ensure pin legs won't be damaged.
Note2: The motherboard might equip with two different types of pin cap. Please refer below instruction to remove the pin cap.

Step 2: Pull the socket locking lever out from the socket and then raise the lever up.

Type A

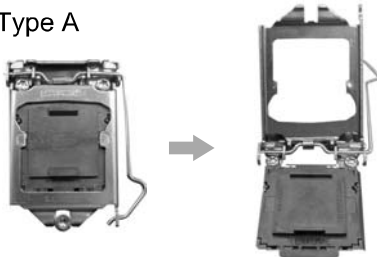

Type B

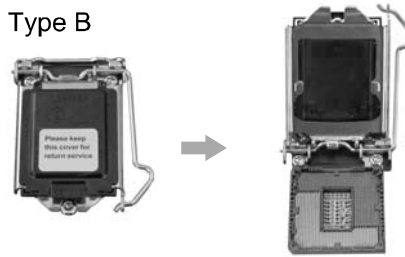

Step 3: Remove the Pin Cap.

Type A

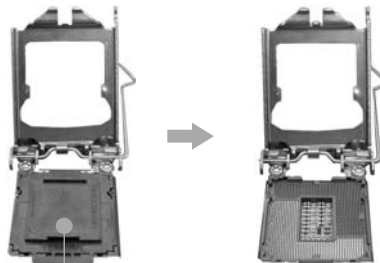

Type B

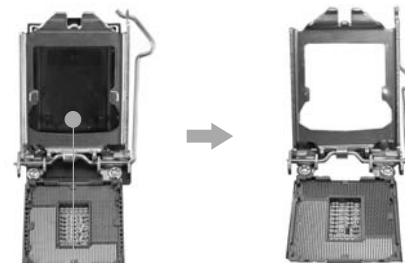

Motherboard Manual

Step 4: Hold processor with your thumb and index fingers, oriented as shown. Align the notches with the socket. Lower the processor straight down without tilting or sliding the processor in the socket.



Note1: The LGA1155 CPU is not compatible with LGA 1150 socket. Do not install a LGA 1155 CPU on the LGA 1150 socket.

Note2: The CPU fits only in one correct orientation. Do not force the CPU into the socket to prevent damaging the CPU.

Step 5: Hold the CPU down firmly, and then lower the lever to locked position to complete the installation.



2.2 Install a Heatsink

Step 1: Place the CPU fan assembly on top of the installed CPU and make sure that the four fasteners match the motherboard holes. Orient the assembly and make the fan cable is closest to the CPU fan connector. Ensure the fastener slots are pointing perpendicular to the heatsink.

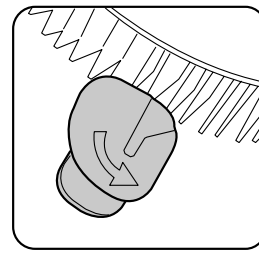

Correct Orientation

Step 2: Press down two fasteners at one time in a diagonal sequence to secure the CPU fan assembly in place. As each fastener locks into position a click should be heard.

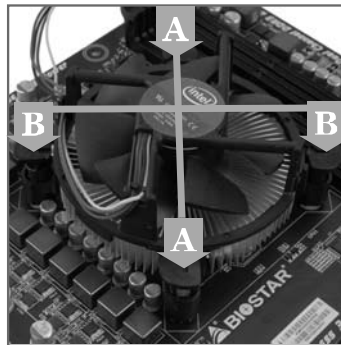

Note1: Do not forget to connect the CPU fan connector.

Note2: For proper installation, please kindly refer to the installation manual of your CPU heatsink.

2.3 Connect Cooling Fans

These fan headers support cooling-fans built in the computer. The fan cable and connector may be different according to the fan manufacturer.

CPU_FAN1: CPU Fan Header

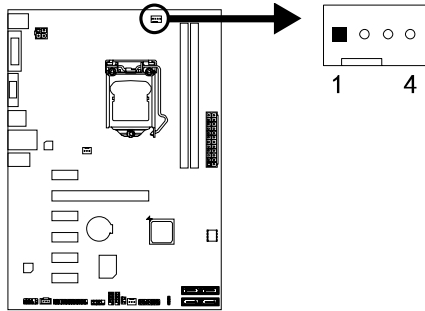

Pin	Assignment
1	Ground
2	+12V
3	FAN RPM rate sense
4	Smart Fan Control (By Fan)

SYS_FAN1/2: System Fan Header

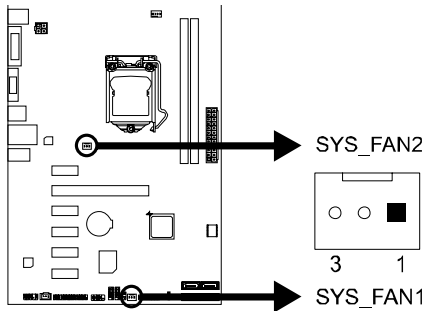

Pin	Assignment
1	Ground
2	+12V
3	FAN RPM rate sense

Note: CPU_FAN1, SYS_FAN1/2 support 4-pin and 3-pin head connectors. When connecting with wires onto connectors, please note that the red wire is the positive and should be connected to pin#2, and the black wire is Ground and should be connected to pin#1(GND).

2.4 Install System Memory

DDR3 Modules

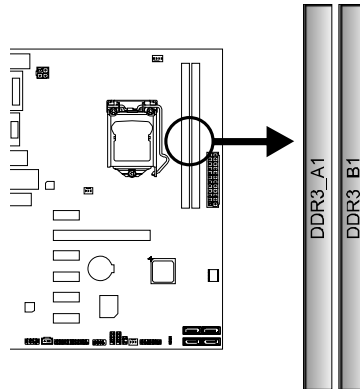

Step 1: Unlock a DIMM slot by pressing the retaining clips outward. Align a DIMM on the slot such that the notch on the DIMM matches the break on the slot.

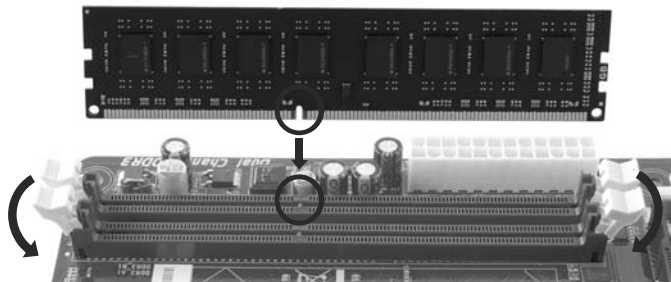

Step 2: Insert the DIMM vertically and firmly into the slot until the retaining clips snap back in place and the DIMM is properly seated.



Note: If the DIMM does not go in smoothly, do not force it. Pull it all the way out and try again.

Memory Capacity

DIMM Socket Location	DDR3 Module	Total Memory Size
DDR3_A1	512MB/1GB/2GB/4GB/8GB	Max is 16GB.
DDR3_B1	512MB/1GB/2GB/4GB/8GB	

Dual Channel Memory Installation

Please refer to the following requirements to activate Dual Channel function:

Install memory module of the same density in pairs, shown in the table.

Dual Channel Status	DDR3_A1	DDR3_B1
Disabled	O	X
Disabled	X	O
Enabled	O	O

(O means memory installed, X means memory not installed.)

Note: The DRAM bus width of the memory module must be the same (x8 or x16)

2.5 Expansion Slots

Install an Expansion Card

You can install your expansion card by following steps:

1. Read the related expansion card's instruction document before install the expansion card into the computer.
2. Remove your computer's chassis cover, screws and slot bracket from the computer.
3. Place a card in the expansion slot and press down on the card until it is completely seated in the slot.
4. Secure the card's metal bracket to the chassis back panel with a screw.
5. Replace your computer's chassis cover.
6. Power on the computer, if necessary, change BIOS settings for the expansion card.
7. Install related driver for the expansion card.

PEX16_1: PCI-Express Gen2 x16 Slot

- PCI-Express 2.0 compliant.
- Maximum theoretical realized bandwidth of 8GB/s simultaneously per direction, for an aggregate of 16GB/s totally.

PEX1_1/1_2/1_3/1_4/1_5: PCI-Express Gen2 x1 Slots

- PCI-Express 2.0 compliant.
- Data transfer bandwidth up to 500MB/s per direction; 1GB/s in total

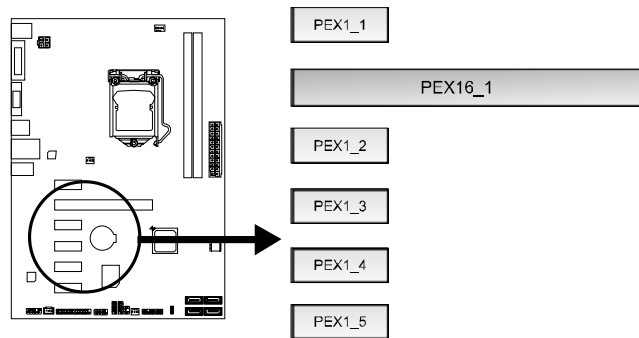

2.6 Jumper Setting

The illustration shows how to set up jumpers. When the jumper cap is placed on pins, the jumper is “close”, if not, that means the jumper is “open”.



JCMOS1: Clear CMOS Jumper

Placing the jumper on pin2-3, it allows user to restore the BIOS safe setting and the CMOS data. Please carefully follow the procedures to avoid damaging the motherboard.

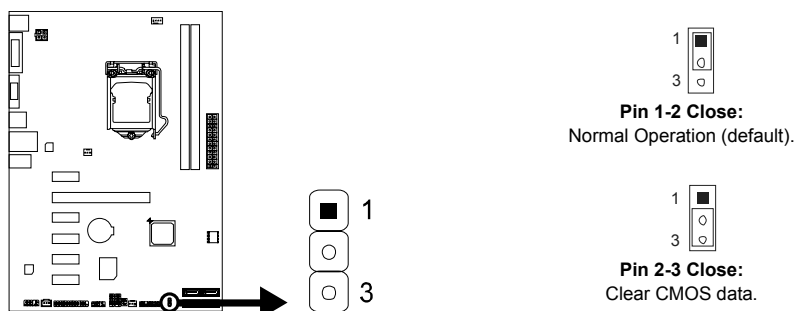

※ Clear CMOS Procedures:

1. Remove AC power line.
2. Set the jumper to “Pin 2-3 close”.
3. Wait for five seconds.
4. Set the jumper to “Pin 1-2 close”.
5. Power on the AC.
6. Load Optimal Defaults and save settings in CMOS.

2.7 Headers & Connectors

ATXPWR1: ATX Power Source Connector

For better compatibility, we recommend to use a standard ATX 24-pin power supply for this connector. Make sure to find the correct orientation before plugging the connector.

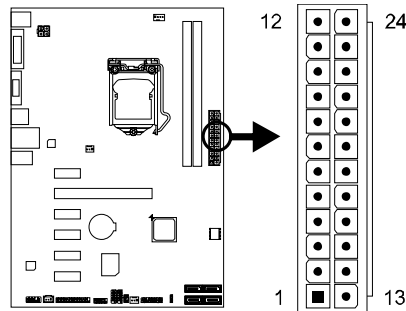

Pin	Assignment	Pin	Assignment
13	+3.3V	1	+3.3V
14	-12V	2	+3.3V
15	Ground	3	Ground
16	PS_ON	4	+5V
17	Ground	5	Ground
18	Ground	6	+5V
19	Ground	7	Ground
20	NC	8	PW_OK
21	+5V	9	Standby Voltage+5V
22	+5V	10	+12V
23	+5V	11	+12V
24	Ground	12	+3.3V

ATXPWR2: ATX Power Source Connector

The connector provides +12V to the CPU power circuit.

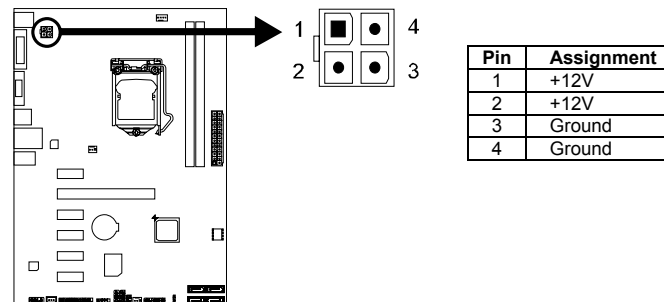

Pin	Assignment
1	+12V
2	+12V
3	Ground
4	Ground

Note1: Before you power on the system, please make sure that both ATXPWR1 and ATXPWR2 connectors have been plugged-in.

Note2: Insufficient power supplied to the system may result in instability or the peripherals not functioning properly. Use of a PSU with a higher power output is recommended when configuring a system with more power-consuming devices.

PANEL1: Front Panel Header

This 16-pin header includes Power-on, Reset, HDD LED, Power LED, and speaker connection. It allows user to connect the PC case's front panel switch functions.

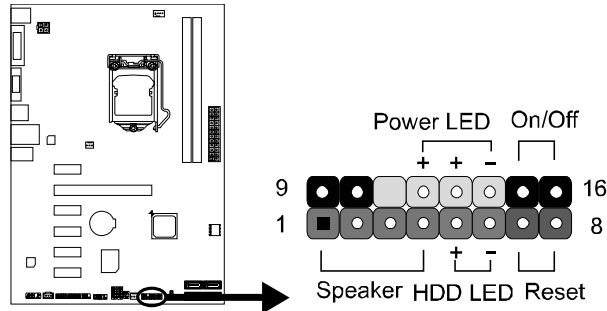

Pin	Assignment	Function	Pin	Assignment	Function
1	+5V	Speaker Connector	9	N/A	N/A
2	N/A		10	N/A	
3	N/A		11	N/A	
4	Speaker		12	Power LED (+)	Power LED
5	HDD LED (+)	13	Power LED (+)		
6	HDD LED (-)	Hard drive LED	14	Power LED (-)	Power-on button
7	Ground	Reset button	15	Power button	
8	Reset control		16	Ground	

SATA1~SATA2: Serial ATA 3.0 Connectors

These connectors connect to SATA hard disk drives via SATA cables. It satisfies the SATA 3.0 specification and with transfer rate of 6.0Gb/s.

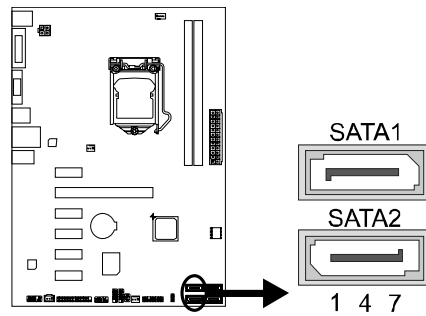

Pin	Assignment
1	Ground
2	TX+
3	TX-
4	Ground
5	RX-
6	RX+
7	Ground

SATA3~SATA4: Serial ATA 2.0 Connectors

These connectors connect to SATA hard disk drives via SATA cables. It satisfies the SATA 2.0 specification and with transfer rate of 3.0Gb/s.

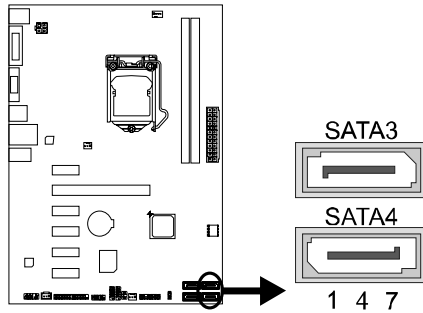

Pin	Assignment
1	Ground
2	TX+
3	TX-
4	Ground
5	RX-
6	RX+
7	Ground

F_USB1/2: Header for USB 2.0 Ports at Front Panel

This header allows user to add additional USB ports on the PC front panel, and also can be connected with a wide range of external peripherals.

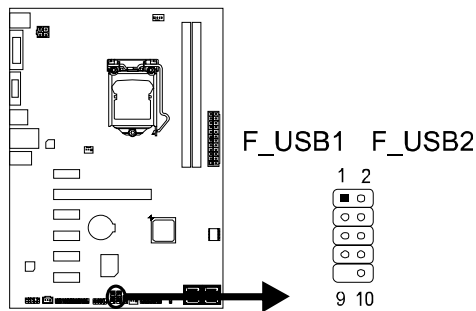

Pin	Assignment
1	+5V (fused)
2	+5V (fused)
3	USB-
4	USB-
5	USB+
6	USB+
7	Ground
8	Ground
9	NC
10	Key

J_COM: Serial Port Header

The motherboard has a serial port header for connecting RS-232 Port.

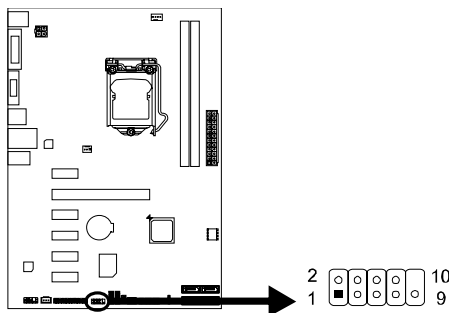

Pin	Assignment
1	Carrier detect
2	Received data
3	Transmitted data
4	Data terminal ready
5	Signal ground
6	Data set ready
7	Request to send
8	Clear to send
9	Ring indicator
10	NC

F_AUDIO1: Front Panel Audio Header

This header allows user to connect the chassis-mount front panel audio I/O which supports HD and AC'97 audio standards.

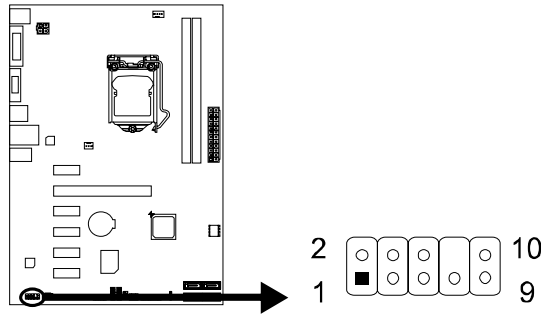

HD Audio		AC'97	
Pin	Assignment	Pin	Assignment
1	Mic Left in	1	Mic In
2	Ground	2	Ground
3	Mic Right in	3	Mic Power
4	GPIO	4	Audio Power
5	Right line in	5	RT Line Out
6	Jack Sense	6	RT Line Out
7	Front Sense	7	Reserved
8	Key	8	Key
9	Left line in	9	LFT Line Out
10	Jack Sense	10	LFT Line Out

Note1: It is recommended that you connect a high-definition front panel audio module to this connector to avail of the motherboard's high definition audio capability.

Note2: Please try to disable the "Front Panel Jack Detection" if you want to use an AC'97 front audio output cable. The function can be found via O.S. Audio Utility.

Note3: To configure 7.1-channel audio, you have to use a chassis with HD front panel audio module and enable the multi-channel audio feature through O.S. Audio Utility.

JSPDIFOUT1: Digital Audio-out Connector

The connector is for connecting the S/SPDIF output bracket.

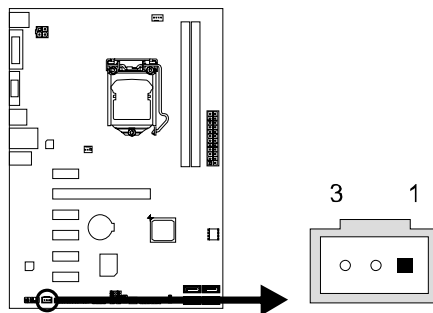

Pin	Assignment
1	+5V
2	SPDIF_OUT
3	Ground

J_PRINT1: Printer Port Header

This header allows user to connect a printer to the PC.

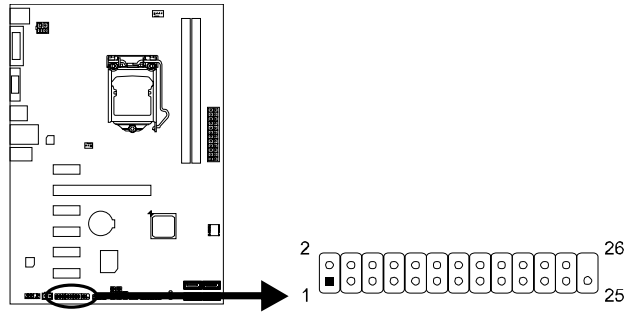

Pin	Assignment	Pin	Assignment
1	-Strobe	14	Ground
2	-ALF	15	Data 6
3	Data 0	16	Ground
4	-Error	17	Data 7
5	Data 1	18	Ground
6	-Init	19	-ACK
7	Data 2	20	Ground
8	-Scltin	21	Busy
9	Data 3	22	Ground
10	Ground	23	PE
11	Data 4	24	Ground
12	Ground	25	SCLT
13	Data 5	26	Key

CIR1: Consumer IR Header

This header is for infrared remote control and communication.

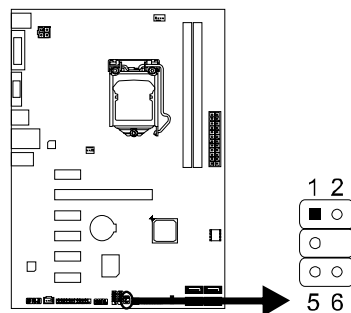

Pin	Assignment
1	IrDA serial input
2	Ground
3	Ground
4	Key
5	IrDA serial output
6	IR Power

CHAPTER 3: UEFI BIOS & SOFTWARE

3.1 UEFI BIOS Setup

- The BIOS Setup program can be used to view and change the BIOS settings for the computer. The BIOS Setup program is accessed by pressing the key after the Power-On Self-Test (POST) memory test begins and before the operating system boot begins.
- For further information of setting up the UEFI BIOS, please refer to the UEFI BIOS Manual in the Setup DVD.

3.2 BIOS Update

The BIOS can be updated using either of the following utilities:

- BIOSSTAR BIOS Flasher: Using this utility, the BIOS can be updated from a file on a hard disk, a USB drive (a flash drive or a USB hard drive), or a CD-ROM.
- BIOSSTAR BIOS Update Utility: It enables automated updating while in the Windows environment. Using this utility, the BIOS can be updated from a file on a hard disk, a USB drive (a flash drive or a USB hard drive), or a CD-ROM, or from the file location on the Web.

BIOSSTAR BIOS Flasher

BIOSSTAR BIOS Flasher is a BIOS flashing utility providing you an easy and simple way to update your BIOS via USB pen drive.

Note1: This utility only allows storage device with FAT32/16 format and single partition.

Note2: Shutting down or resetting the system while updating the BIOS will lead to system boot failure.

Updating BIOS with BIOSSTAR BIOS Flasher

1. Go to the website to download the latest BIOS file for the motherboard.
2. Then, copy and save the BIOS file into a USB flash (pen) drive.
3. Insert the USB pen drive that contains the BIOS file to the USB port.
4. Power on or reset the computer and then press <F12> during the POST process.

5. After entering the POST screen, the BIOS-FLASHER utility pops out. Choose [fs0] to search for the BIOS file.



6. Select the proper BIOS file, and a message asking if you are sure to flash the BIOS file. Click Yes to start updating BIOS.



7. A dialog pops out after BIOS flash is completed, asking you to restart the system. Press the [Y] key to restart system.



8. While the system boots up and the full screen logo shows up, press key to enter BIOS setup. After entering the BIOS setup, please go to the **Save & Exit**, using the **Restore Defaults** function to load Optimized Defaults, and select **Save Changes and Reset** to restart the computer. Then, the BIOS Update is completed.

BIOS Update Utility (through the Internet)

1. Installing BIOS Update Utility from the DVD Driver.
2. Please make sure the system is connected to the internet before using this function.

3. Launch BIOS Update Utility and click the **Online Update** button on the main screen.



Motherboard Manual

4. An open dialog will show up to request your agreement to start the BIOS update. Click **Yes** to start the online update procedure.

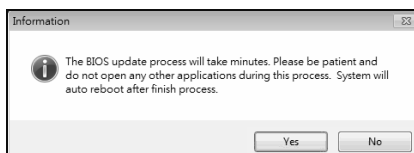

5. If there is a new BIOS version, the utility will ask you to download it. Click **Yes** to proceed.

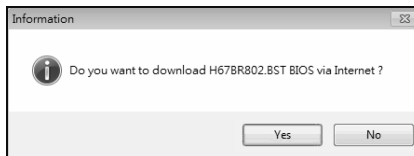

6. After the download is completed, you will be asked to program (update) the BIOS or not. Click **Yes** to proceed.

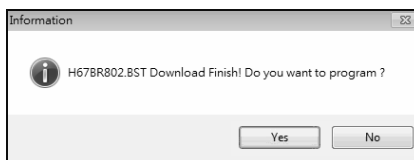

7. After the updating process is finished, you will be asked you to reboot the system. Click **OK** to reboot.

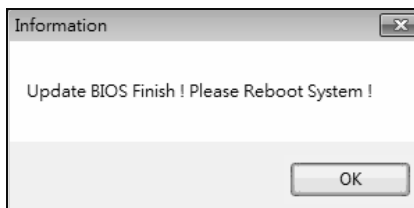

8. While the system boots up and the full screen logo shows up, press key to enter BIOS setup. After entering the BIOS setup, please go to the **Save & Exit**, using the **Restore Defaults** function to load Optimized Defaults, and select **Save Changes and Reset** to restart the computer. Then, the BIOS Update is completed.

BIOS Update Utility (through a BIOS file)

1. Installing BIOS Update Utility from the DVD Driver.
2. Download the proper BIOS from <http://www.biostar.com.tw/>

3. Launch BIOS Update Utility and click the **Update BIOS** button on the main screen.



4. A warning message will show up to request your agreement to start the BIOS update. Click **OK** to start the update procedure.



5. Choose the location for your BIOS file in the system. Please select the proper BIOS file, and then click on **Open**. It will take several minutes, please be patient.

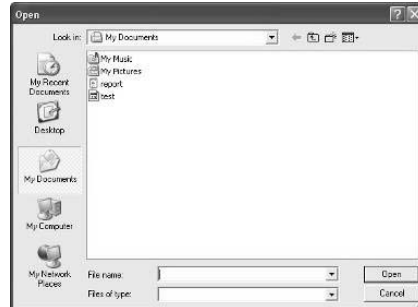

6. After the BIOS Update process is finished, click on **OK** to reboot the system.

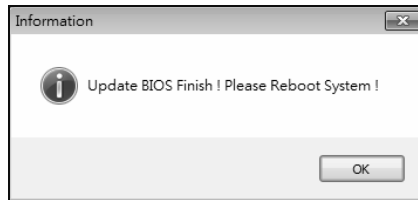

7. While the system boots up and the full screen logo shows up, press key to enter BIOS setup. After entering the BIOS setup, please go to the **Save & Exit**, using the **Restore Defaults** function to load Optimized Defaults, and select **Save Changes and Reset** to restart the computer. Then, the BIOS Update is completed.

Backup BIOS

Click the Backup BIOS button on the main screen for the backup of BIOS, and select a proper location for your backup BIOS file in the system, and click **Save**.

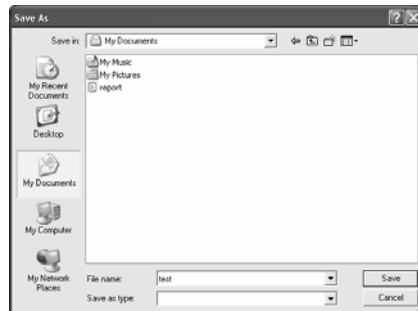

3.3 Software

Installing Software

1. Insert the Setup DVD to the optical drive. The driver installation program would appear if the Auto-run function has been enabled.
2. Select **Software Installation**, and then click on the respective software title.
3. Follow the on-screen instructions to complete the installation.

Launching Software

After the installation process is completed, you will see the software icon showing on the desktop. Double-click the icon to launch it.

Note1: All the information and content about following software are subject to be changed without notice. For better performance, the software is being continuously updated.

Note2: The information and pictures described below are for your reference only. The actual information and settings on board may be slightly different from this manual.

BIOScreen Utility

This utility allows you to personalize your boot logo easily. You can choose BMP as your boot logo so as to customize your computer.



Please follow the step-by-step instructions below to update boot logo:

- Load Image : Choose the picture as the boot logo.
- Transform : Transform the picture for BIOS and preview the result.
- Update Bios : Write the picture to BIOS Memory to complete the update.

eHot-Line

eHot-Line is a convenient utility that helps you to contact with our Tech-Support system. This utility will collect the system information which is useful for analyzing the problem you may have encountered, and then send these information to our tech-support department to help you fix the problem.

Note: Before you use this utility, please set Outlook Express as your default e-mail client application program.

*represents important information that you must provide. Without this information, you may not be able to send out the mail.

This block will show the information which would be collected in the mail.

*Describe condition of your system.

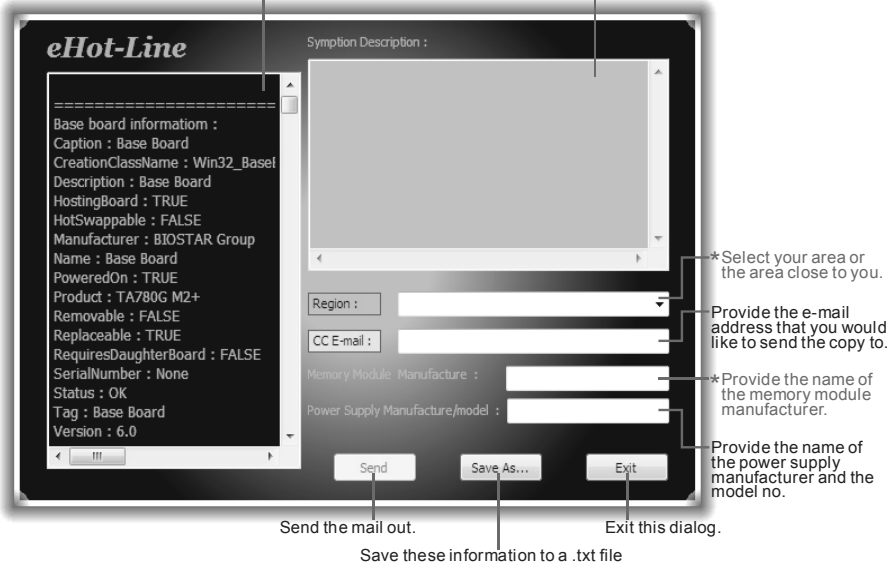

After filling up this information, click “Send” to send the mail out. A warning dialog would appear asking for your confirmation; click “Send” to confirm or “Do Not Send” to cancel.

If you want to save this information to a .txt file, click “Save As...” and then you will see a saving dialog appears asking you to enter file name.



Motherboard Manual

Enter the file name and then click “**Save**”. Your system information will be saved to a .txt file.

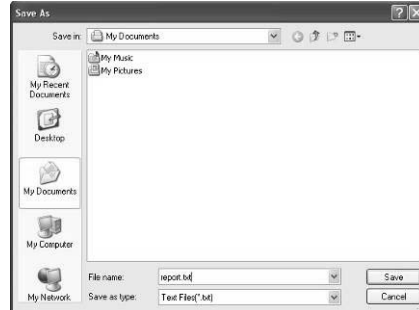

Open the saved .txt file, you will see your system information including motherboard/BIOS/CPU/video/ device/OS information. This information is also concluded in the sent mail.

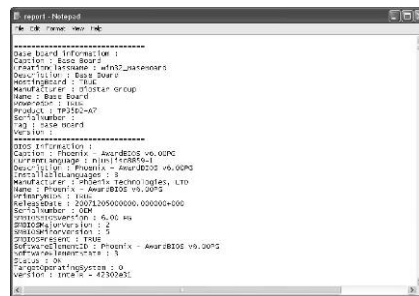

Note1: We will not share customer's data with any other third parties, so please feel free to provide your system information while using eHot-Line service.

Note2: If you are not using Outlook Express as your default e-mail client application, you may need to save the system information to a .txt file and send the file to our tech support with other e-mail application. Go to the following website <http://www.biostar.com.tw/app/en/about/contact.php> for getting our contact information.

Smart EAR

Hi-Fi Audio Requirements:

1. A chassis with front audio output jacks
2. An earphone or a headphone
3. Windows 7 or Windows 8 operation system

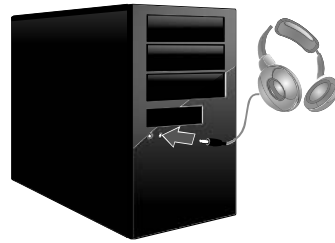

Installation Guide:

1. Make sure the front audio cable of the chassis connected to the front audio header of the motherboard properly.
2. Install the Smart Ear Utility from the driver DVD.
3. Connect the earphone or headphone to the front audio jack of the chassis.

Note: If you want to use an AC'97 front audio output cable, please disable the "Front Panel Jack Detection" setting. This setting can be found via O.S. Audio Utility.

Smart EAR Utility:

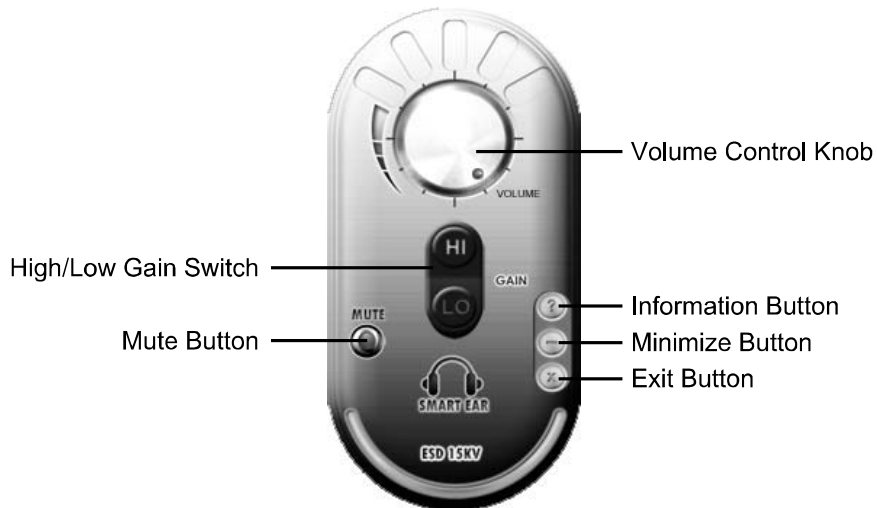

- **High/Low Gain Switch:** Keep the gain switch to low for low impedance headphone and set to high for high impedance headphone.
- **Mute Button:** To disable system sound
- **Volume Control Knob:** The volume can be finely adjusted by turning the knob either clockwise or anti-clockwise to increase or decrease system volume accordingly.
- **Information Button:** Get information of the application
- **Minimize Button:** Minimize the application window to the taskbar
- **Exit Button:** Exit the application

Smart Connect Technology

Intel® Smart Connect Technology is designed to update programs by periodically waking your computer from sleep/standby mode for a short time. This function works with applications that automatically get their data from the Internet.

System Requirement:

- Intel Smart Connect Technology enabled in BIOS Setup
- Set the “ACPI Sleep State” to S3 in BIOS Setup.
- Windows 7 and Windows 8
- Normal internet connection

Configuring Intel Smart Connect Technology

Step 1: After installing the operating system and motherboard drivers, install the Intel Smart Connect Technology application. Restart your computer when completed.

Step 2: Click on start menu and input "regedit" in the search bar. Press enter to open the registry editor. Look for the following directory in the registry editor:

Computer\HKEY_LOCAL_MACHINE\SOFTWARE\Intel\Intel Smart Connect Technology

Right-click on *Intel Smart Connect Technology* and select *New > Key*. Type “OEM”.

Note: Intel Smart Connect Technology is for S3 mode only. During the updating process, the monitor will not light up and no sound will be output from the speaker.

Step 3: As shown in the screenshot below, right-click on OEM, select *New > Multi-String Value*, and type “WhiteList”. Double-click *WhiteList* and type the application name to be added in *Edit Multi-String*. For example, to add Microsoft Live Mail, type “wmail.exe”. Restart your computer when completed.

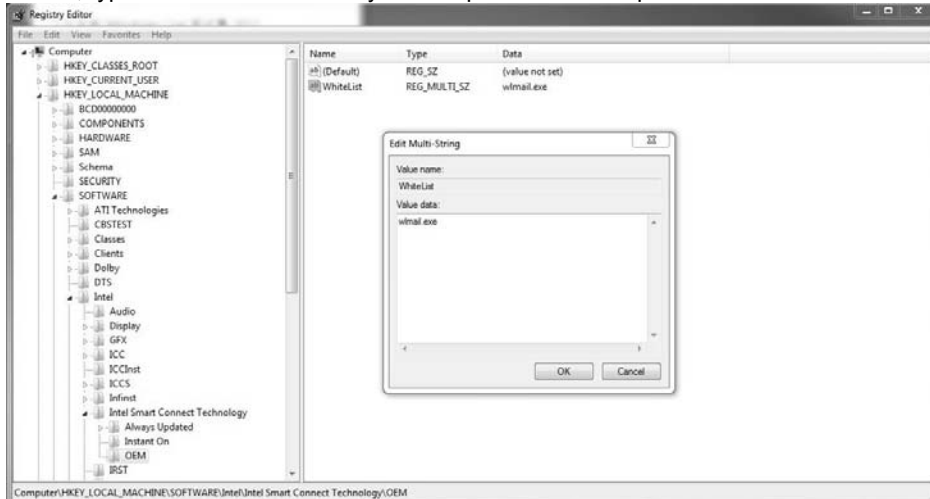

Step 4: After completing the steps above, go to Start\All Programs\Intel and launch Intel(R) Smart Connect Technology.

Basic and advanced settings

Basic Tab

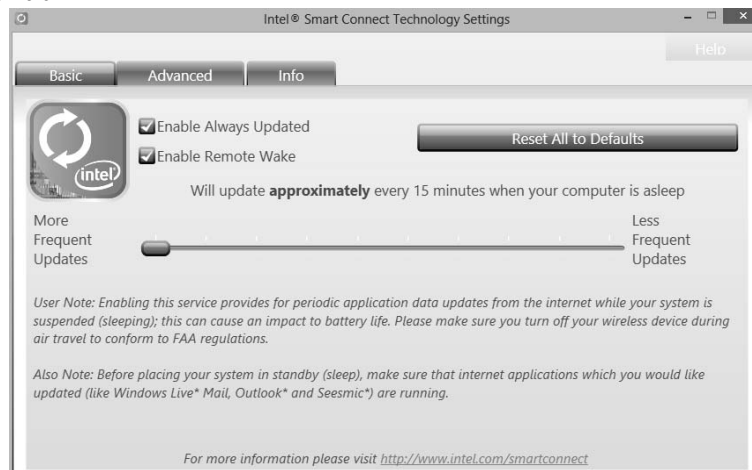

Update Frequency slider: This slider bar sets the amount of time the feature waits to wake your computer and update your applications. Move the slider in the user interface to change the frequency. The slider bar can be set to wake and update your computer from every 15 to 60 minutes. The longer the time between updates the less power the feature consumes.

Reset All to Defaults button: This button is designed to reset Intel® Smart Connect Technology back to the original factory setting for wake frequency.

Advanced Tab



Extended Power Savings: You can set a time for Intel Smart Connect Technology to work in Extended Power Savings mode. This night time mode updates your computer every two hours, saving power for the times you are not using your computer.

Rapid Start Technology

Intel® Rapid Start technology enables your system to get up and running faster from even the deepest sleep, saving time and power consumption. Feel secure knowing that your system will still resume to working conditions in the event of unexpected power loss while in sleep mode.

System Requirement:

- An Intel® SATA SSD (SATA Gen2 or Gen3. Preferably Gen3, and 80 GB or larger)
- Windows 7 and Windows 8

Note1: Please visit below webpage for more details about operating systems supporting http://www.intel.com/p/en_US/support

Installing Intel® RST:

Step 1: BIOS Setting

1-1 Go to [Advanced Menu] > [ACPI Settings], and set [ACPI Sleep State] to S3 (Suspend to RAM)

1-2 Go to [Advanced Menu] > [SATA Configuration], and set [SATA Mode Selection] to AHCI

1-3 Go to [Advanced Menu] and set [Intel(R) Rapid Start Technology] to Enabled

1-4 Save your changes, and then exit the BIOS Setup.

Step 2: Operating System Installation

Step 3: Installing Intel® Rapid Start Application

3-1 Insert the setup Driver DVD into your optical drive. Click “Intel Rapid Start Technology” to launch the program.

3-2 Below window will pop-out, then click “Create Disk” to start disk partition. After disk partition finished, please click “OK” then system will reboot automatically.



3-3 After rebooting, the system will setup Intel® Rapid Start Technology automatically. We recommend you restart the system after this installation is complete,



Step 4: Configuring Intel® Rapid Start Application

Launch the Intel® Rapid Start Technology Manager application from [Start] > [All Programs] > [Intel] or click the icon  in the notification area.



CHAPTER 4: USEFUL HELP

4.1 Driver Installation

After you installed your operating system, please insert the Fully Setup Driver DVD into your optical drive and install the driver for better system performance.

You will see the following window after you insert the DVD



The setup guide will auto detect your motherboard and operating system.

A. Driver Installation

To install the driver, please click on the Driver icon. The setup guide will list the compatible driver for your motherboard and operating system. Click on each device driver to launch the installation program.

B. Software Installation

To install the software, please click on the Software icon. The setup guide will list the software available for your system, click on each software title to launch the installation program.

C. Manual

Aside from the paperback manual, we also provide manual in the Driver DVD. Click on the Manual icon to browse for available manuals.

Note1: If this window didn't show up after you insert the Driver DVD, please use file browser to locate and execute the file SETUP.EXE under your optical drive.

Note2: You will need Acrobat Reader to open the manual file. Please download the latest version of Acrobat Reader software from <http://get.adobe.com/reader/>

4.2 AMI BIOS Beep Code

Boot Block Beep Codes

Number of Beeps	Description
Continuing	Memory sizing error or Memory module not found

POST BIOS Beep Codes

Number of Beeps	Description
1	Success booting.
8	Display memory error (system video adapter)

4.3 Troubleshooting

Probable	Solution
<ol style="list-style-type: none"> There is no power in the system. Power LED does not shine; the fan of the power supply does not work Indicator light on keyboard does not shine. 	<ol style="list-style-type: none"> Make sure power cable is securely plugged in. Replace cable. Contact technical support.
System is inoperative. Keyboard lights are on, power indicator lights are lit, and hard drives are running.	Using even pressure on both ends of the DIMM, press down firmly until the module snaps into place.
System does not boot from a hard disk drive, but can be booted from optical drive.	<ol style="list-style-type: none"> Check cable running from disk to disk controller board. Make sure both ends are securely plugged in; check the drive type in the standard CMOS setup. Backing up the hard drive is extremely important. All hard disks are capable of breaking down at any time.
System only boots from an optical drive. Hard disks can be read, applications can be used, but system fails to boot from a hard disk.	<ol style="list-style-type: none"> Back up data and applications files. Reformat the hard drive. Re-install applications and data using backup disks.
Screen message shows "Invalid Configuration" or "CMOS Failure."	Review system's equipment. Make sure correct information is in setup.
System cannot boot after user installs a second hard drive.	<ol style="list-style-type: none"> Set master/slave jumpers correctly. Run SETUP program and select correct drive types. Call the drive manufacturers for compatibility with other drives.

CPU Overheated

If the system shutdown automatically after power on system for seconds, that means the CPU protection function has been activated.

When the CPU is over heated, the motherboard will shutdown automatically to avoid a damage of the CPU, and the system may not power on again.

In this case, please double check:

1. The CPU cooler surface is placed evenly with the CPU surface.
2. CPU fan is rotated normally.
3. CPU fan speed is fulfilling with the CPU speed.

After confirmed, please follow steps below to relief the CPU protection function.

1. Remove the power cord from power supply for seconds.
2. Wait for seconds.
3. Plug in the power cord and boot up the system.

Or you can:

1. Clear the CMOS data.
2. Wait for seconds.
3. Power on the system again.

APPENDIX: Specifications in Other Languages

Arabic

المواصفات	
المأخذ 1150 لمعالج إيه إم دي Intel® Core i7 / i5 / i3 / Pentium / Celeron الحد الأقصى للطاقة الحرارية في تصميم المعالج (TDP – thermal design power) : 95 واط. * يرجى الرجوع إلى الموقع www.biostar.com.tw لقائمة دعم المعالج CPU.	قاعدة وحدة المعالجة المركزية
INTEL® H81	مجموعة الشرائح
DDR3 1066/ 1333/ 1600 تدعم قناة مزدوجة دي. دي. ار. 2x دي. دي. ار. DDR3 فتحات الذاكرة المزدوجة DIMM، تتحمل كحد أقصى 16 جيجابايت ذاكرة كل فتحة مزدوجة DIMM تتحمل دون ECC 512 ميجا بايت / 8/4/2/1 جيجابايت دي. دي. ار. DDR3 * يرجى الرجوع إلى الموقع www.biostar.com.tw لقائمة دعم الذاكرة.	الذاكرة
Intel® H81 تتحمل رايد AHCI وصلة 2x ساتا SATA 6 جيجا بايت / الثانية وصلة 2x ساتا SATA 3 جيجا بايت / الثانية	التخزين
ريالتيك رت ل REALTEK RTL 8111G 10 / 100 / 1000 ميجا بايت / الثانية ، تحديد تلقائي ، النصف / القدرة القصوى المزدوجة	شبكة محلية LAN
Biostar Hi-Fi ALC892 ، 7.1 قنوات عالية النقا	الترميز الصوتي
منافذ 2 x ناقل متسلسل عام USB 3.0 (2 في المداخل والمخارج الخلفية) منافذ 6 x ناقل متسلسل عام USB 2.0 (2 في المداخل والمخارج الخلفية و 4 من خلال الموزع الداخلي)	ناقل متسلسل عام USB
5 x فتحة منفذ الملحقات الإضافية PCIe 2.0 x 1 1 x فتحة منفذ الملحقات الإضافية PCIe 2.0 x 16 (x16)	فتحات التوسع
1 x PS/2 لوحة المفاتيح 1 x PS/2 لوحة الماوس فتحة توصيل عدد 1 x واجهة مرئية رقمية DVI فتحة توصيل عدد 1 x منظومة العرض المرئي VGA فتحة توصيل عدد 2 x ناقل متسلسل عام USB 3.0 فتحة توصيل عدد 2 x ناقل متسلسل عام USB 2.0 فتحة لتوصيل عدد 1 x الشبكة المحلية LAN فتحة توصيل عدد 3 x جاك للصوت	المداخل والمخارج الخلفية
وصلة 2 x SATA 6 جيجا بايت / الثانية وصلة 2 x SATA 3 جيجا بايت / الثانية موزع 2 x ناقل متسلسل عام USB 2.0 (كل موزع يتحمل فتحتين ناقل متسلسل عام USB 2.0) وصلة للطاقة 1 x 4 دببيس وصلة للطاقة 1 x 24 دبوس وصلة 1 x مروحة تبريد وحدة المعالجة المركزية وصلة 2 x مراوح تبريد المنظومة موزع 1 x اللوحة الأمامية موزع 1 x الصوت الأمامي موزع 1 x سيموس مباشر موزع 1 x فتحة تسلسلية وصلة 1 x خارجية S/PDIF سوني فيليبس الواجهة الرقمية موزع 1 x فتحة للطباعة موزع 1 x مستهلك IR	المداخل والمخارج الداخلية
عامل شكل مدد التكنولوجيا المتقدمة ATX ، 295x 210 مم	عامل الشكل
ويندوز 7 / ويندوز 8 بيوستار BIOSTAR تحتفظ بحق إضافة أو إزالة الدعم لأي نظام تشغيل مع أو بدون أنظار.	أنظمة التشغيل المدعومة

Spécifications	
Support Unité Centrale	Socket 1150 Processeurs Intel® Core i7 / i5 / i3 / Pentium / Celeron Enveloppe thermique Unité Centrale maximum : 95Watt * Veuillez vous reporter à www.biostar.com.tw pour la liste des supports modèles d'Unité Centrale.
Jeu de puces	INTEL® H81
Mémoire	Supporte mémoire DDR3 double canal 1066/ 1333/ 1600 Banc de mémoire 2 x DDR3 DIMM, Supporte max. jusqu'à une mémoire de 16 GB Chaque module DIMM supporte module DDR3 non-ECC 512MB/ 1/ 2/ 4/ 8 GB * Veuillez vous reporter à www.biostar.com.tw pour la liste des soutien de la mémoire.
Stockage	INTEL® H81, Supporte SRT Connecteur 2 x SATA 6Gb/s Connecteur 2 x SATA 3Gb/s
Réseau local	Realtek RTL 8111G, 10/ 100/ 1000 Mb/s auto négociation, capacité bidirectionnelle à l'alternat / bidirectionnelle simultanée
Codec audio	ALC892, Canaux 7.1, écoute audio de haute définition, Biostar Hi-Fi
USB	Port 2x USB 3.0 (2 sur les I/O) Port 6x USB 2.0 (2 sur les I/O arrières et 4 en interne)
Connecteur d'extension	5x PCIe 2.0 x1 Fente 1x PCIe 2.0 x16 Fente (x16)
I/O arrières	1x PS/2 Clavier 1x PS/2 Souris 1x Port DVI 1x Port VGA 2x Port USB 3.0 2x Port USB 2.0 1x port LAN 3x entrées audio
I/O en interne	2x Connecteur SATA 6.0Gb/s 2x Connecteur SATA 3.0Gb/s 2x embases USB 2.0 (chaque embase supporte 2 Ports USB 2.0) 1x 4-Broche de carte 1x 24-Broche de carte 1x Connecteur ventilateur unité centrale 2x Connecteur ventilateur système 1x Fiche panneau avant 1x Fiche audio avant 1x Fiche mémoire CMOS vide 1x Embase port série 1x Connecteur sortie S/PDIF 1x Embase port imprimante 1x Fiche Registre d'état Consommateur
Facteur d'encombrement	Facteur d'encombrement ATX, 295 mm x 210 mm
Support SE	Windows 7/ 8, Biostar se réserve le droit d'ajouter ou d'enlever le support pour toute SE avec ou sans préavis.

German

Spezifikationen	
CPU-Unterstützung	Anschluss-1150 für Intel® Core i7 / i5 / i3 / Pentium / Celeron Prozessor Maximale CPU TDP (Thermal Design Power): 95 Watt * Bitte konsultieren Sie www.biostar.com.tw für CPU-Unterstützungsliste
Chipset	INTEL® H81
Festplattenspeicher	Unterstützt zweikanaliges DDR3 1066/ 1333/ 1600 2 x DDR3 DIMM-SpeicherSlot, Max. Unterstützung bis zu 16 GB-Speicher Jedes DIMM unterstützt nicht-ECC 512MB/ 1/ 2/ 4/ 8 GB DDR3-Module * Bitte konsultieren Sie www.biostar.com.tw für Speicherunterstützung Liste.
Arbeitsspeicher	INTEL® H81, Unterstützt AHCI 2x SATA 6Gb-Verbindung 2x SATA 3Gb-Verbindung
LAN	Realtek RTL 8111G, 10/ 100/ 1000 Mb Auto-Negotiation, Halb- / Voll-Duplex-fähig
Audio-Codec	ALC892, 7.1 Kanäle, HD-Audio, Biostar Hi-Fi
USB	2x USB 3.0-Port (2 hintere I/Os) 6x USB 2.0-Port (2 hintere I/Os und 4 via interne Header)
Erweiterungsanschlüsse	5x PCIe 2.0 x1-Slot 1x PCIe 2.0 x16-Slot (x16)
Hintere I/Os	1x PS/2-Maus 1x PS/2-Tastatur 1x DVI-Port 1x VGA-Port 2x USB 3.0-Port 2x USB 2.0-Port 1x LAN-Port 3x Audio Jack
Interne I/Os	2x SATA 6.0Gb/s-Verbindung 2x SATA 3.0Gb/s-Verbindung 2x USB 2.0-Header (jeder Header unterstützt 2 USB 2.0-Ports) 1x 4-Pin-Stromverbindung 1x 24-Pin-Stromverbindung 1x CPU-Ventilatorverbindung 2x System-Ventilatorverbindung 1x Header für Frontpanel 1x Header für Frontaudio 1x Header für klares CMOS 1x Serieller Port-Header 1x S/PDI-Auswurfsverbindung 1x Header für Druckeranschluss 1x Consumer IR-Header
Formfaktor	ATX Formfaktor, 295 mm x 210 mm
OS-Unterstützung	Windows 7/ 8 Biostar reserves the right to add or remove support for any OS with or without notice.

Italian

Specificazioni	
Supporto processore	Slot 1150 per processore Intel® Core i7 / i5 / i3 / Pentium / Celeron Alimentazione di Proiezione Termico (TDP – Thermal Design Power): 95Watt * Si prega di consultare www.biostar.com.tw per la lista di supporto del processore.
Tipo scheda	INTEL® H81
Memoria	Supporta DDR3 1066/ 1333/ 1600 Doppio Canale 2 x DDR3 DIMM Slot di Memoria Supporta fino a 16 GB Memoria Ogni DIMM supporta non-ECC 512MB/ 1/ 2/ 4/ 8 GB DDR3 moduli * Si prega di consultare www.biostar.com.tw per la lista di supporto del memoria.
Memorizzazione	INTEL® H81, Supporta AHCI Connettore 2x SATA 6Gb/s Connettore 2x SATA 3Gb/s
Catena	Realtek RTL 8111G 10/ 100/ 1000 Mb auto negoziazione, capacita di duplex Meta / Completo
Codec Audio	ALC892, Canali Audio di Alta Definizione 7.1, Biostar Hi-Fi
USB	Slot 2x USB 3.0 (2 nei ingressi/ uscite posteriore) Slot 6x USB 2.0 (2 nei ingressi/ uscite posteriore e 4 da distributori interni)
Slot di espansione	Slot 5x PCIe 2.0 x1 Slot 1x PCIe 2.0 x16 (x16)
Ingressi/ Uscite Posteriore	Mouse 1x PS/2 Tastiera 1x PS/2 Slot 1x DVI Slot 1x VGA Slot 2x USB 3.0 Slot 2x USB 2.0 Slot 1x LAN Jack audio 3x
Ingressi/ Uscite Interni	Connettore 2x SATA 6.0Gb/s Connettore 2x SATA 3.0Gb/s Distributore 2x USB 2.0 (ogni distributore supporta 2 slot USB 2.0) Connettore con 4 pin x1 Connettore con 24 pin x1 Connettore Ventilatore processore x1 Connettore Ventilatore Sistema x2 Distributore Pannello Frontale x1 Distributore Audio Frontale x1 Distributore CMOS Diretto x1 Distributore Slot Serie x1 Connettore esterno S/PDIF x1 Distributore Slot Stampante x1 Distributore Consumabile IR x1
Fattore di Forma	Fattore di Forma ATX, 295 mm x 210 mm
Supporto SO	Windows 7/ 8 Biostar si riserva il diritto di aggiungere o ritirare il supporto per qualsiasi SO con o senza preavviso.

Japanese

仕様	
CPU サポート	Intel® Core i7 / i5 / i3 / Pentium / Celeron プロセッサの Socket 1150 最大 CPU TDP (Thermal Design Power 最大放熱量) :95 W *CPU サポート リストについては、 www.biostar.com.tw を参照してください。
チップセット	INTEL® H81
メモリ	デュアルチャンネル1066/ 1333/ 1600 をサポート 2 x DDR3 DIMM メモリ スロット、最大 16 GB メモリまでサポート 各 DIMM は、非-ECC 512MB/ 1/ 2/ 4/ 8 GB DDR3 モジュールをサポートしています *サポートされているメモリのリストについては、 www.biostar.com.tw を参照してください。
保存スペース	INTEL® H81, AHCI のサポート 2x SATA 6Gb/s コネクタ 2x SATA 3Gb/s コネクタ
LAN	Realtek RTL 8111G 10/ 100/ 1000 Mb/s オートネゴシエーション、半/全 二重通信
オーディオ コーデック	ALC892 7.1 チャンネル、ハイ デフィニション オーディオ, Biostar Hi-Fi
USB	2x USB 3.0 ポート (後部 I/O に2つ) 6x USB 2.0 ポート (後部 I/O に2つ 及び 内蔵ヘッダー経由に4つ)
拡張スロット	5x PCIe 2.0 x1 スロット 1x PCIe 2.0 x16 スロット(x16)
後部 I/O	1x PS/2 マウス 1x PS/2 キーボード 1x DVI ポート 1x VGA ポート 2x USB 3.0 ポート 2x USB 2.0 ポート 1x LAN ポート 3x オーディオ ジャック
内蔵 I/O	2x SATA 6.0Gb/s コネクタ 2x SATA 3.0Gb/s コネクタ 2x USB 2.0 ヘッダー (各ヘッダーは、2つの USB 2.0 ポートをサポートしています) 1x 4-Pin パワー コネクタ 1x 24-Pin パワー コネクタ 1x CPU ファン コネクタ 2x システム ファン コネクタ 1x フロント パネル ヘッダー 1x フロント オーディオ ヘッダー 1x クリア CMOS ヘッダー 1x シリアル ポート ヘッダー 1x S/PDIF アウト コネクタ 1x プリンター ポート ヘッダー 1x コンシューマー IR ヘッダー
フォーム ファクタ	ATX フォーム ファクタ、295 mm x 210 mm
サポート OS	Windows 7/ 8 Biostar には、通知なしでサポート OS を変更する権限があります。

Polish

Specyfikacje techniczne	
Obsługa procesora	Gniazdo procesora (Socket) 1150 dla procesorów Intel® Core i7 / i5 / i3 / Pentium / Celeron Moc Wydzielanego Ciepła (TDP - Thermal Design Power): 95Watt * Proszę sprawdzić listę obsługiwanych procesorów na stronie internetowej www.biostar.com.tw
Rodzaj płyty	INTEL® H81
Pamięć	Obsługa pamięci DDR3 1066/ 1333/ 1600 Dwukanałowa 2 x DDR3 DIMM Pamięć Gniazda procesora (Slot), Maksymalna wielkość pamięci 16 GB Każdy DIMM obsługuje jeden moduł non-ECC 512MB/ 1/ 2/ 4/ 8 GB DDR3 * Proszę sprawdzić listę obsługiwanych pamięć na stronie internetowej www.biostar.com.tw
Przechowywanie	INTEL® H81, Obsługa AHCI Złącze 2x SATA 6Gb/s, Złącze 2x SATA 3Gb/s
LAN	Układ RTL 8111G, 10/ 100/ 1000 Mb auto negocjacja, pojemność duplex Połowe / Pełny
Codec Audio	ALC892, Kanały Audio wysokiej Definicji 7.1, Biostar Hi-Fi
USB	2 x złącza USB 3.0 (2 przez tylne porty) 6 x złącza USB 2.0 (2 przez tylne porty wejścia/ wyjścia oraz 4 przez wewnętrzne porty)
Złącza rozszerzeń	złącze 5x PCIe 2.0 x1 (Slot) złącza 1x PCIe 2.0 x16 (Slot) (x16)
Tylne porty wejścia/ wyjścia	Myszka 1x PS/2 Klawiatura 1x PS/2 Port 1x DVI Port 1x VGA Porty 2x USB 3.0 Porty 2x USB 2.0 Port 1x LAN Porty audio 3x
Wewnętrzne porty wejścia/ wyjścia	Złącza 2x SATA 6.0Gb/s Złącza 2x SATA 3.0Gb/s Złącza 2x USB 2.0 (każde złącze obsługuje dodatkowe 2 porty USB 2.0) Złącza 4 pionowe x 1 Złącza 24 pionowe x 1 Złącze wentylatora CPU x 1 Złącze wentylatora obudowy x 2 Złącze przedniego panelu x1 Złącze audio przedniego panelu x1 Złącze bezpośrednie CMOS x1 Port szeregowy x1 Port zewnętrzny S/PDIF x1 Złącze port drukarki x1 Złącze konsument IR x1
Obudowa	Obudowa ATX, 295 mm x 210 mm
Obsługa OS	Windows 7/ 8 Biostar zastrzega sobie prawo do dodania lub wycofania obsługi dla OS, z wypowiedzeniem lub bez wypowiedzenia.

Portuguese

Especificações	
Suporte Processador	Porta 1150 para processador Intel® Core i7 / i5 / i3 / Pentium / Celeron Alimentação de Design Térmico (TDP – Thermal Design Power): 95Watt * Por favor consulte www.biostar.com.tw para obter uma lista de suporte do processador.
Tipo Placa Mãe	INTEL® H81
Memória	Suporta DDR3 1066/ 1333/ 1600 Canal Duplo 2 x DDR3 DIMM Slot de memória Suporta até 16 GB Memória Cada DIMM suporta non-ECC 512MB/ 1/ 2/ 4/ 8 GB DDR3 módulo * Por favor consulte www.biostar.com.tw para obter uma lista de suporte do memória.
Armazenamento	INTEL® & H81, Suporta AHCI Conector 2x SATA 6Gb/s Conector 2x SATA 3Gb/s
LAN	Realtek RTL 8111G 10/ 100/ 1000 Mb auto negociação, capacidade duplex Metade / Cheio
Codec de Audio	ALC892, Canais de Áudio de Alta Definição 7.1, Biostar Hi-Fi
USB	Porta 2x USB 3.0 (2 nas entradas/saídas traseiras) Porta 6x USB 2.0 (2 nas entradas/saídas traseiras e 4 pelos Dispositivos internos)
Slots de expansão	Porta 5x PCIe 2.0 x1 Porta 1x PCIe 2.0 x16 (x16)
Entradas/Saídas no painel traseiro	Mouse 1x PS/2 Teclado 1x PS/2 Porta 1x DVI Porta 1x VGA Porta 2x USB 3.0 Porta 2x USB 2.0 Porta 1x LAN Soquete audio 3x
Conectores na placa	Conector 2x SATA 6.0Gb/s Conector 2x SATA 3.0Gb/s Dispositivo 2x USB 2.0 (cada Dispositivo suporta 2 portas USB 2.0) Conector de 4 pinos x1 Conector de 24 pinos x1 Conector de Ventoinha processador x1 Conector de Ventoinha Sistema x2 Dispositivo Painel Frontal x1 Dispositivo de Audio Frontal x1 Dispositivo CMOS Direct x1 Dispositivo Porta Série x1 Conector Externo S/PDIF x1 Dispositivo Porta Impressora x1 Dispositivo Consumível IR x1
Fator de Fôrma	Fator de Fôrma ATX, 295 mm x 210 mm
Suporte OS	Windows 7/ 8 Biostar reserva seu direito de adicionar ou retirar o suporte para qualquer OS com ou sem notificação.

Russian

Спецификации	
Поддержка центрального процессора	Сокет 1150 для процессоров Intel® Core i7 / i5 / i3 / Pentium / Celeron Максимальный термopakет центрального процессора (TDP): 95 ватт * Перечень поддержки центрального процессора смотрите на www.biostar.com.tw .
Набор микросхем	INTEL® H81
Память	Поддерживает двухканальный 1066/ 1333/ 1600 2 гнезда платы памяти DDR3 DIMM, максимальная память до 16 Гб Каждый модуль DIMM поддерживает модуль не-ECC 512 Мб/ 1/ 2/ 4/ 8 Гб DDR3 * Перечень поддержки памяти смотрите на www.biostar.com.tw .
Накопитель	INTEL® H81, Поддерживает AHCI Соединитель 2x SATA 6 Гб/с Соединитель 2x SATA 3 Гб/с
Локальная сеть	Realtek RTL 8111G Автосогласование 10/ 100/ 1000 Мб/с, работает в полно/полудуплексном режиме
Аудиокодек	ALC892, Каналы 7.1, высококачественное аудио, Biostar Hi-Fi
USB	2 порта USB 3.0 (2 сзади ввода-вывода) 6 порта USB 2.0 (2 сзади ввода-вывода и 4 через внутренние контакты)
Гнезда расшир.	5x PCIe 2.0 x1 гнездо 1x PCIe 2.0 x16 гнездо (x16)
Задняя плата ввода-вывода	1 мышь PS/2 1 клавиатура PS/2 1 порт DVI 1 порт VGA 2 порта USB 3.0 2 порта USB 2.0 1 порт локальной сети 3 гнезд для подключения наушников
Внутр. Плата ввода-вывода	Соединитель 2x SATA 6 Гб/с Соединитель 2x SATA 3 Гб/с 2 контакта USB 2.0 (каждый контакт поддерживает 2 порта USB 2.0) 1 4-выводный разъем питания 1 24-выводный разъем питания 1 разъем вентилятора ЦП 2 разъема вентилятора системы 1 контакт передней панели 1 контакт передней аудиопанели 1 контакт микросхемы Clear CMOS 1 контакт последовательного порта 1 соединитель S/PDIF-Out 1 контакт порта принтера 1 инфракрасный пользовательский контакт
Конструктив	Форм-фактор ATX, 295 мм x 210 мм
Поддержка ОС	Windows 7/ 8 Biostar оставляет за собой право добавлять или удалять поддержку любой ОС, с уведомлением или без.

Spanish

Especificaciones	
Compatibilidad con el procesador	Ranura 1150 para procesador Intel® Core i7 / i5 / i3 / Pentium / Celeron Alimentación de Proyección Térmica (TDP – Thermal Design Power): 95Watt *Por favor consultar con www.biostar.com.tw para la lista de compatibilidad con el procesador.
Tipo de Placa	INTEL® H81
Memoria	Soporta DDR3 1066/ 1333/ 1600 Doble Canal 2x DDR3 DIMM Ranura de memoria Soporta hasta 16 GB Memoria Cada DIMM soporta un modulo non-ECC 512MB/ 1/ 2/ 4/ 8 GB DDR3 *Por favor consultar con www.biostar.com.tw para la lista de compatibilidad con el memoria.
Almacenamiento de información	INTEL® H81, Soporta AHCI Conector 2x SATA 6Gb/s, Conector 2x SATA 3Gb/s
LAN	Realtek RTL 8111G 10/ 100/ 1000 Mb/s auto negociación, capacidad dúplex Mitad/Completo
Códec Audio	ALC892, Canales Audio de Alta Definición 7.1, Biostar Hi-Fi
USB	Ranura 2x USB 3.0 (2 en las entrada/salidas posteriores) Ranura 6x USB 2.0 (2 en las entrada/salidas posteriores y 4 por los distribuidores internos)
Ranuras de Extinción	Ranura 5x PCIe 2.0 x1 Ranura 1x PCIe 2.0 x16 (x16)
Panel trasero de E/S	Ratón 1x PS/2 Teclado 1x PS/2 Ranura 1x DVI Ranura 1x VGA Ranura 2x USB 3.0 Ranura 2x USB 2.0 Ranura 1x LAN Socket audio 3x
Conectores en placa	Conector 2x SATA 6Gb's Conector 2x SATA 3Gb's Distribuidor 2x USB 2.0 (cada distribuidor soporta 2 ranuras USB 2.0) Conector con 4 patillas x1 Conector con 24 patillas x1 Conector Ventilador procesador x1 Conector Ventilador Sistema x2 Distribuidor Panel Frontal x1 Distribuidor Audio Frontal x1 Distribuidor CMOS Directo x1 Distribuidor Ranura Serie x1 Conector Externo S/PDIF x1 Distribuidor Ranura Impresora x1 Distribuidor Consumible IR x1
Factor de Forma	Factor de Forma ATX, 295 mm x 210 mm
Soporte OS	Windows 7/ 8 Biostar reserva su derecho de añadir o retirar el soporte para cada OS con o sin notificación.

2013/07/23